

NOTE:1
 MAXIMUM FAN DIAMETER (BLADES HORIZONTAL - AS SHIPPED) EQUALS NOMINAL FAN DIAMETER.
 ADJUSTMENT OF ±1.5 INCHES POSSIBLE AT INSTALLATION

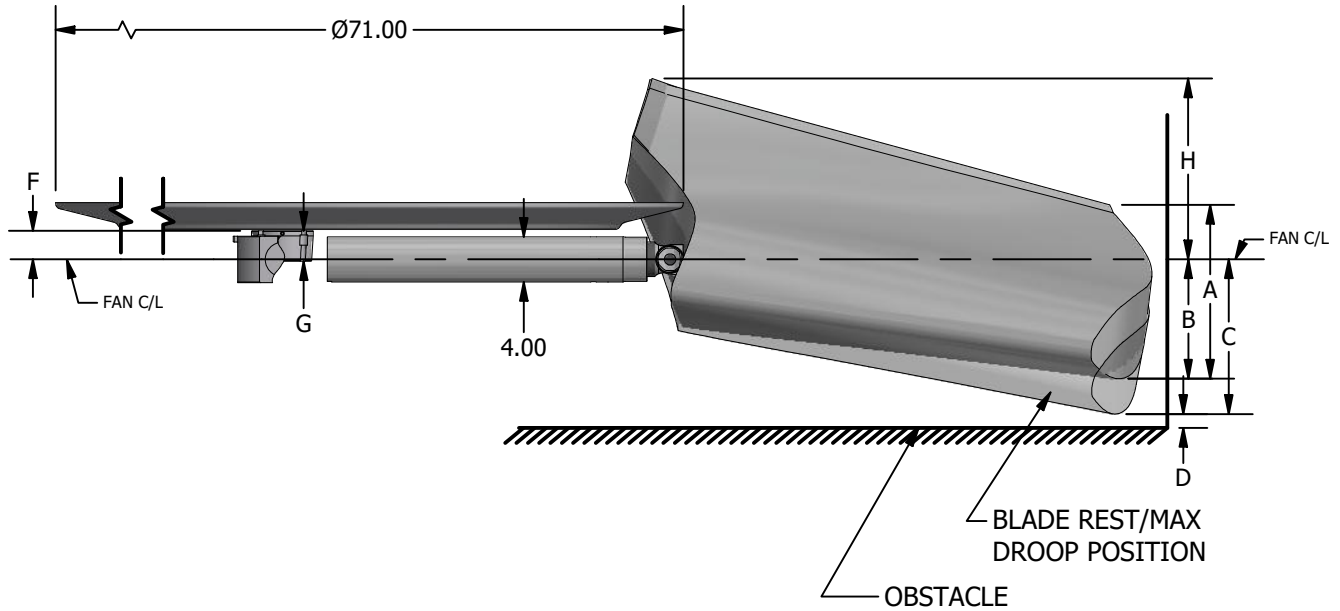

A=BLADE TIP PROFILE HEIGHT (PATH WIDTH)
 B=BLADE RUNNING DROOP (C/L TO BOTTOM OF BLADE)
 C=MAXIMUM DROOP POSITION OF BLADES AT 30° (C/L TO BOTTOM OF BLADE)
 D=MINIMUM RECOMMENDED OBSTACLE CLEARANCE ON AIR INLET SIDE
 H=MAXIMUM HEIGHT OF BLADE AT 30° (C/L TO AIR OUTLET SIDE)

F=FAN CENTERLINE TO BASE OF BUSHING (STANDARD HUB WITHOUT EXTENSION)
 G=OVERALL BUSHING HEIGHT
 L=MAX BUSHING TORQUE FT. LBS
 #=WITH S.A.E. STANDARD KEYWAY IN BUSHING
 *=WITH SHALLOW KEYWAY IN BUSHING
 °=MAX METRIC BORE WITH STANDARD KEYWAY

DIA	BLADE ANGLE			PERCENT BLADE LOADING		C	D	H
	10°	20°	30°	100%	75%			
	A		B					
13.0'	14.2"	21.9"	29.7"	13.0"	12.0"	14.0"	6"	23.1"
14.0'	14.2"	21.9"	29.7"	14.0"	13.0"	16.0"	6"	23.1"
15.0'	14.2"	21.9"	29.7"	15.0"	14.0"	18.0"	6"	23.1"

BUSHING TYPE	NUMBER OF BLADES	MAX # BORE	MAX * BORE	MAX ° BORE	F	G	L
U	3	2.75"	2.938"	75	2.525"	2.7"	4000
W	4,5	3.75"	4.000"	100	2.725"	2.8"	7300



SERIES 72 RIGHT HAND ROTATION